



Hospital TV 32LN662M

UL-Listed Hospital TV

* All images in this datasheet are for illustrative purposes only.



32LN662M

Screen Size	32"
Stand Type	No Stand
Resolution	1,366 × 768 (HD)
Front Color	Ceramic Black
Broadcasting	ATSC, Clear QAM, Analog NTSC
Speaker	5 W + 5 W (2.0 ch)
Solution	Pro:Centric (Smart, Cloud, Direct, V), Quick Menu



Pillow Speaker Ready

The hospital TV is equipped with a compatible pillow speaker* interface, giving patients the ability to control the TV sound and video from their bed.

* Pillow speaker is not provided by LG. (sold separately)

Nurse Call System Ready

Through nurse call system provided by a pillow speaker* connected to LG hospital TV, staff can be called immediately for emergency.

UL Hospital Grade Listed

The hospital TV is designed for the healthcare and hospital environment meeting UL safety requirements.

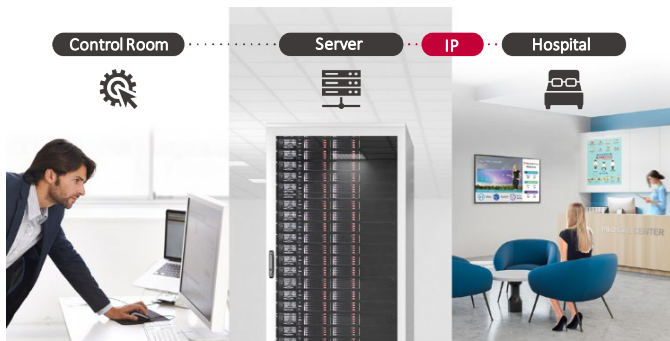

Pro:Centric Hospital Management Solution

The Pro:Centric Direct solution offers simple editing tools, making it easy to perform service and IP network-based remote management. Hospitals can not only edit the user interface and service menus of the LG Hospital TVs but also manage them all at once.

* The actual screen may be slightly different. Some features may not be supported based on PCD versions.

SoftAP

Software-enabled Access Point (SoftAP) is a "virtual" Wi-Fi feature that uses TV as a wireless hotspot, enabling patients to connect their own devices to the SoftAP.

* SoftAP should be set in the installation menu after the TV is turned on.
** Screen Share may not be operated at the same time.



Pro:Idiom

The LN662M provides embedded Pro:Idiom decryption, unlocking access to high-value digital content with Pro:Idiom DRM (Digital Right Management) which prevents illegal copying of the content.



USB Cloning

USB data cloning makes managing multiple displays easy. Instead of setting up each display one by one, data can be copied to a USB for one display, and be sent to the other displays through a USB plug-in.

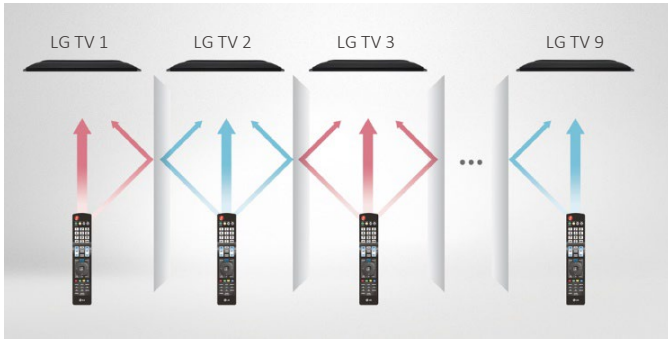

Multi-code IR

Multi-code IR* function eliminates any remote-control signal interaction between multiple TVs in one place. LG hospital TV supports this when used with the Multi-code IR remote control, so users can freely control their own TVs without disturbing the others.

* Multi-code IR remote control is not provided by LG. (sold separately)

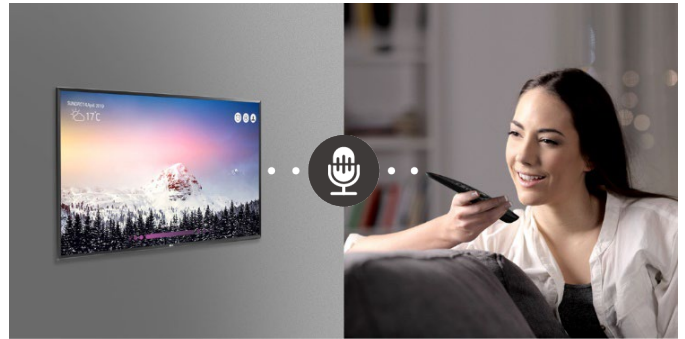

Voice Recognition

For seamless interaction and user satisfaction, LG has applied voice recognition function to the 32LN662M hospital TV. This feature makes it easy to control the TV without pressing buttons on the remote control.

* Magic Motion Remote is required (sold separately).

DIMENSIONS

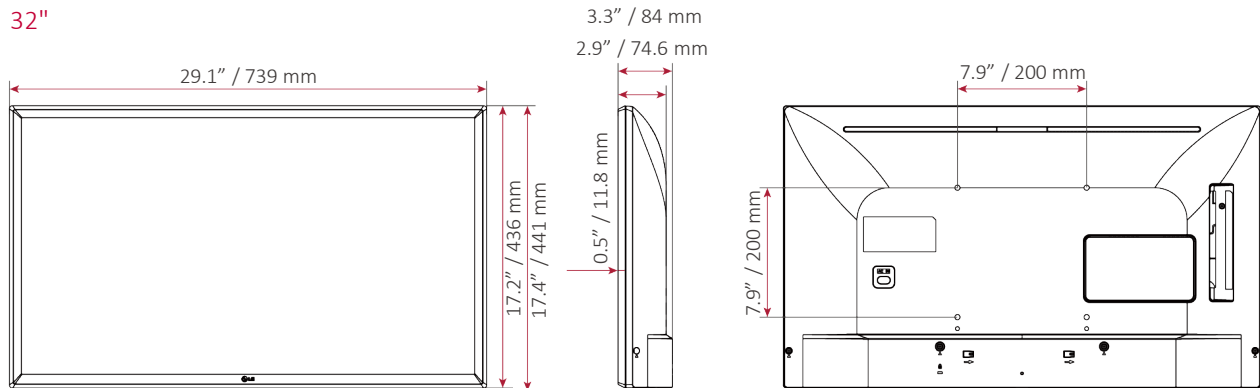

CONNECTIVITY

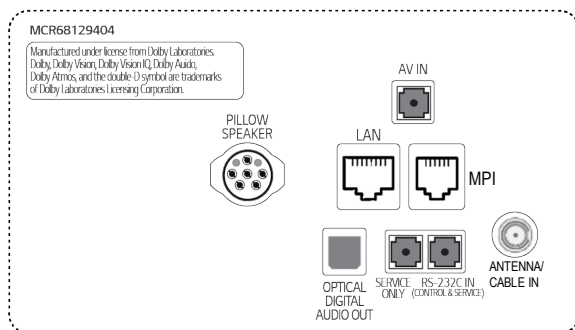

SPECIFICATIONS

32LN662MBUB

Category	Category	Pro:Centric Smart
Design	Stand Type	No Stand
	Front Color	Ceramic Black
Display	Inch	32"
	Resolution	1,366 × 768 (HD)
	Nano	No
Video	HDR (Dolby Vision / 10 Pro / HLG)	No / Yes / Yes
Audio	Speaker (Sound Output)	5 W + 5 W
	Speaker System	2.0 ch
	DOLBY ATMOS	No
	LG Sound Sync	Optical/Bluetooth wireless
Broadcasting System	Digital (Terrestrial, Cable, Satellite)	ATSC / Clear QAM
	Analog (NTSC / SECAM / PAL)	NTSC
	Global IPTV Support	Yes
Hospitality Solution	Solution Type	Pro:Centric (Smart, Cloud, Direct, V), Quick Menu 5.0
	DRM	Yes
Smart Features	webOS22, Web Browser, Pre-loaded App, SDP Server Compatibility, Magic Remote Compatibility (Ready, MR18HA), SoftAP, Wi-Fi, Screen Share (Miracast), Smart Share, Bluetooth Audio Playback, HDMI-ARC (HDMI2), SNMP, HTNG-CEC (1.4), Multi-code IR	
Hospitality Features	Welcome Screen (Splash Image), Insert Image, One Channel Map (LCM), Instant ON, Motion Eye Care, RJP (Remote Jack Pack) Compatibility (Teleadapt/Guestlink, HDMI CEC), Pillow Speaker, NTP Sync Timer	
Connectivity	Set Side	HDMI In 2.0 (x2), USB 2.0
	Set Rear	Antenna/Cable In (Tuner), AV In (3.5 mm Stereo), Optical Digital Audio Out, RS-232C In (3.5 mm TRRS, Control & Service), Service Only (3.5 mm Stereo), LAN (RJ45), MPI (RJ12), Pillow Speaker Interface (6 Pin)
Mechanical	VESA Compatible (mm)	200 × 200
	Dimensions (W × H × D) / Weight	29.1 x 17.4 x 3.3 in. / 10.7 lbs. 739 × 441 × 84 mm / 4.85 kg
	Shipping Weight	13.3 lbs. / 6.05 kg
Electrical	Power Supply	120 Vac, 50/60 Hz
	Power Consumption	39.2 W (Typ.) / 45.3 W (Max.)
	Standby Power Consumption	Less than 0.5 W
Warranty & Other	Warranty	3 Year Limited
	UPC	1 95174 04699 9
	Certifications	UL, FCC
	Accessories	Power Cable (1.8 m Angle Type)

* Specifications are subject to change without notice. Please make sure to check the product manual for details about product usage.